

KENWOOD

Patissier

MX310 series

MX320 series

instructions

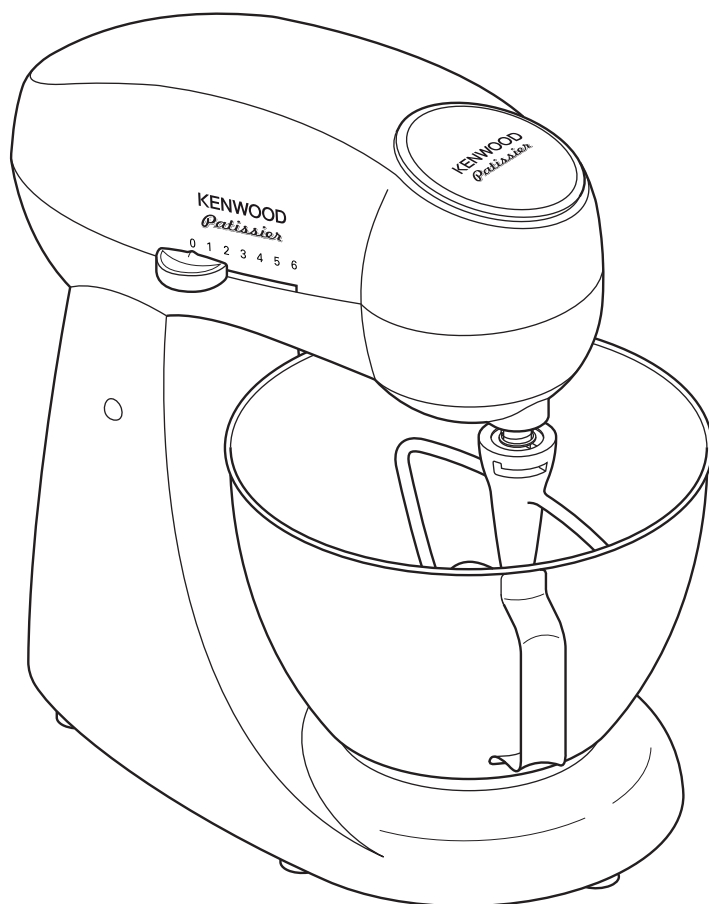

English

2 - 18

عربي

٢٤ - ١٩

know your Kenwood kitchen machine

safety

- Switch off and unplug before fitting or removing tools, after use and before cleaning.
- Keep children away from the machine and never let the cord hang down where a child could grab it.
- Keep your fingers away from moving parts and fitted tools. Never put your fingers etc in the hinge mechanism.
- Never leave the machine on unattended.
- Never use a damaged machine. Get it checked or repaired: see 'service', page 7.
- Never use an unauthorised tool.
- Never operate the mixer with the head in the raised position.
- Never let the power unit, cord or plug get wet.
- Never exceed the maximum capacities on page 5.
- Take care when lifting this appliance as it is heavy. Ensure the head is locked and that the bowl, tools, and cord are secure before lifting.
- This appliance is not intended for use by persons (including children) with reduced physical, sensory or mental capabilities, or lack of experience and knowledge, unless they have been given supervision or instruction concerning use of the appliance by a person responsible for their safety.
- Children should be supervised to ensure that they do not play with the appliance.
- Only use the appliance for its intended domestic use. Kenwood will not accept any liability if the appliance is subject to improper use, or failure to comply with these instructions.

before plugging in

- Make sure your electricity supply is the same as the one shown on the underside of your machine.

important - UK only

- The wires in the cord are coloured as follows:
Green and Yellow = Earth,
Blue = Neutral,
Brown = Live.
- The appliance must be protected by a 13A approved (BS1362) fuse.
- **WARNING: THIS APPLIANCE MUST BE EARTHED.**

Note:

- For non-rewireable plugs the fuse cover MUST be refitted when replacing the fuse. If the fuse cover is lost then the plug must not be used until a replacement can be obtained. The correct fuse cover is identified by colour and a replacement may be obtained from your Kenwood Authorised Repairer (see Service).
- If a non-rewireable plug is cut off it must be DESTROYED IMMEDIATELY. An electric shock hazard may arise if an unwanted non-rewireable plug is inadvertently inserted into a 13A socket outlet.
- This appliance conforms to EC directive 2004/108/EC on Electromagnetic Compatibility and EC regulation no. 1935/2004 of 27/10/2004 on materials intended for contact with food.

before using for the first time

- 1 Remove all packaging, including the fitment around the bowl.
- 2 Wash the parts: see 'care and cleaning', page 6.

know your Kenwood kitchen machine

- ① tool socket
- ② mixer head
- ③ Kenwood badge - this is a non-removable part
- ④ on/off and speed switch
- ⑤ head-lift lever
- ⑥ power unit
- ⑦ bowl
- ⑧ pouring shield (if included)
- ⑨ beater
- ⑩ whisk
- ⑪ dough hook
- ⑫ flexible beater (if supplied)

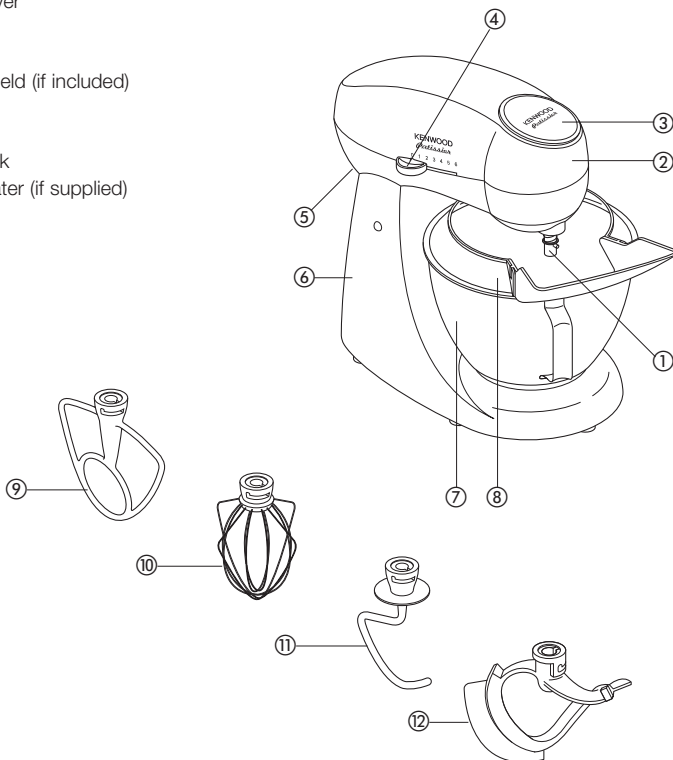

the mixer

the mixing tools and some of their uses

- beater ● For making cakes, biscuits, pastry, icing, fillings, éclairs and mashed potato.
- flexible beater ● For creaming and mixing soft ingredients. It is not to be used with heavy recipes such as dough or hard ingredients.
- whisk ● For eggs, cream, batters, fatless sponges, meringues, cheesecakes, mousses, soufflés. Don't use the whisk for heavy mixtures (eg creaming fat and sugar) - you could damage it.
- dough hook ● For yeast mixtures.

to use your mixer

- 1 Push up on the head release lever at the back of the appliance **1** and at the same time lift the head until it locks in the raised position.
- to insert a tool 2 Line the pin on the shaft with the slot on the inside of the tool, push up and turn clockwise to lock **2**.
- 3 Fit the bowl onto the base, press down and turn clockwise to lock **3**.
- 4 Push up on the head release lever and at the same time lower the mixer head **1**.
- 5 Switch on and move the speed switch to the desired setting **4**.
- to remove a tool 6 Push up, turn anti-clockwise and pull off.

- hints ● Switch off and scrape the bowl with a spatula when necessary.
- Eggs at room temperature are best for whisking.
- Before whisking egg whites, make sure there's no grease or egg yolk on the whisk or bowl.
- Use cold ingredients for pastry unless your recipe states otherwise.
- When creaming fat and sugar for cake mixes, always use the fat at room temperature or soften it first.
- Your mixer has been fitted with 'soft start' feature to minimise spillage. However if the machine is switched on with a heavy mixture in the bowl such as bread dough, you may notice that the mixer takes a few seconds to reach the selected speed.

points for bread making

- important ● Never exceed the maximum capacities on page 5 - you will overload the machine.
- To protect the life of the machine always allow a rest of 20 minutes between loads.
- Some movement of the mixer head is normal. If you hear the machine labouring, switch off, remove half the dough and do each half separately.
- The ingredients mix best if you put the liquid in first.
- At intervals stop the machine and scrape the mixture off the dough hook.
- Different batches of flour vary considerably in the quantities of liquid required and the stickiness of the dough can have a marked effect on the load imposed on the machine. You are advised to keep the machine under observation whilst the dough is being mixed; the operation should take no longer than 5 minutes.

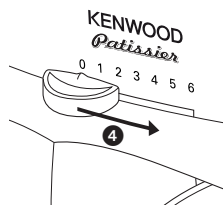
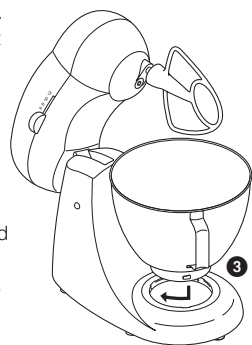
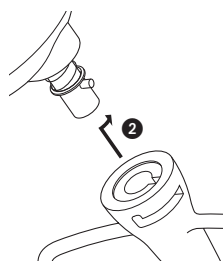
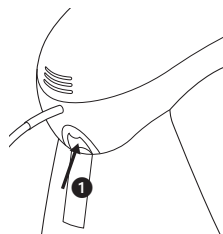

speed switch

These are a guide only and will vary depending upon the quantity of mix in the bowl and the ingredient being mixed.

- beater ● **creaming fat and sugar** start on 1, gradually increasing to 6.
- **beating eggs into creamed mixtures** 3 - 6.
- **folding in flour, fruit etc** 1 - 2.
- **all in one cakes** start on speed 1 - 2, gradually increase to 6.
- **rubbing fat into flour** 1 - 2.
- whisk ● Gradually increase to 6.
- dough hook ● Start on 1, gradually increasing to 6.

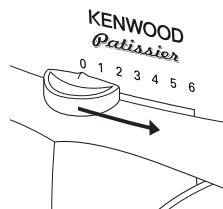

maximum capacities

- shortcrust pastry** ● 500g flour
- fruit cake mix** ● 2 Kg total mix
- stiff bread dough** ● 650g flour
- soft bread dough** ● 650g flour
- egg whites** ● 12 (A minimum of 2 medium size egg whites can be whisked).

electronic speed sensor control

Your mixer is fitted with an electronic speed sensor control that is designed to maintain the speed under different load conditions, such as when kneading bread dough or when eggs are added to a cake mix. You may therefore hear some variation in speed during the operation as the mixer adjusts to the load and speed selected - this is normal.

to use the flexible beater (if supplied)

Carefully fit the flexible wiper blade onto the tool by locating the base of the wiper blade into the slot **5**, then feed one side into the groove before gently hooking the end in place **6**. Repeat with the other side **7**.

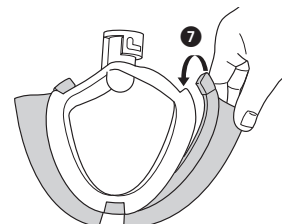
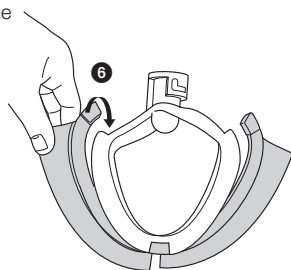
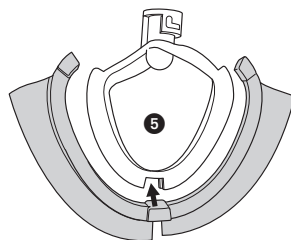

to fit and use your pouring shield

- 1 Raise the mixer head until it locks.
 - 2 Fit the bowl and the desired tool.
 - 3 Slide the narrow section of the pouring shield under the mixer attachment **8**.
 - 4 Fit the pouring shield onto the bowl.
 - 5 Turn the pouring shield until the narrow section of the shield aligns with the groove on the tool socket **9**.
 - 6 Lower the mixer head.
 - 7 Turn the opening of the pouring shield to the desired position.
 - 8 Fit the chute onto the pouring shield by locating the tabs in the slots **10**.
 - 9 To remove the pouring shield reverse the operation.
- During mixing, ingredients can be added directly to the bowl via the chute.

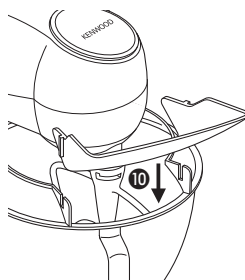
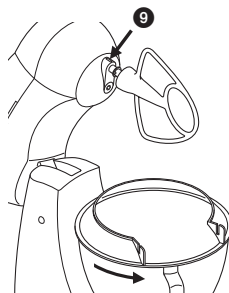
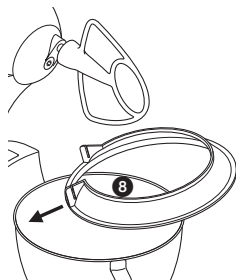

cleaning and service

care and cleaning

- Always switch off and unplug before cleaning.
- power unit
- Wipe with a damp cloth, then dry.
 - Never use abrasives or immerse in water.
- bowl, tools,
pouring shield
- Wash by hand, then dry thoroughly or wash in the dishwasher.
 - Never use a wire brush, steel wool or bleach to clean your stainless steel bowl. Use vinegar to remove limescale.
 - Keep away from heat (cooker tops, ovens, microwaves).
- flexible beater
- Always remove the flexible wiper blade from the tool before cleaning **11**.
 - Wash the flexible wiper blade and tool in hot soapy water, then dry thoroughly. Alternatively the parts can be washed in a dishwasher.
- Note: Please inspect the condition of the tool body before and after use and also regularly inspect the condition of the wiper blade and replace it if there are any signs of wear.

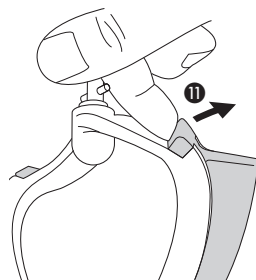

service and customer care

- If the cord is damaged it must, for safety reasons, be replaced by KENWOOD or an authorised KENWOOD repairer.

UK If you need help with:

- using your machine
- servicing or repairs (in or out of guarantee)
- ☎ call KENWOOD Customer Care on 023 92392333.

Have your model number ready - it's on the underside of the mixer.

- spares and attachments
- ☎ call 0844 557 3653.

other countries ● Contact the shop where you bought your machine.

- Made in China.



IMPORTANT INFORMATION FOR CORRECT DISPOSAL OF THE PRODUCT IN ACCORDANCE WITH EC DIRECTIVE 2002/96/EC.

At the end of its working life, the product must not be disposed of as urban waste. It must be taken to a special local authority differentiated waste collection centre or to a dealer providing this service.

Disposing of a household appliance separately avoids possible negative consequences for the environment and health deriving from inappropriate disposal and enables the constituent materials to be recovered to obtain significant savings in energy and resources. As a reminder of the need to dispose of household appliances separately, the product is marked with a crossed-out wheeled dustbin.

guarantee UK only

- If your machine goes wrong within one year from the date you bought it, we will repair or replace it free of charge provided:
- you have not misused, neglected or damaged it;
- it has not been modified;
- it is not second-hand;
- it has not been used commercially;
- you have not fitted a plug incorrectly; and
- **you supply your receipt to show when you bought it.**

This guarantee does not affect your statutory rights.

recipes

Fill your home with the delicious aroma of cakes, pastries and cookies that your Patisserie mixer has helped create!

Important Beater

The speeds in the recipes are based on using the beater. Some adjustment may be necessary if the flexible beater is used instead. Remember the flexible beater should only be used for creaming and mixing soft ingredients.

	page
strawberries and cream sponge	9
rich chocolate cake	9
gingerbread	10
raspberry streuselkucken	10
lemon curd tartlets	11
shortcrust pastry and variations	11
citrus meringue pie	12
pavlova	12
white chocolate mousse	13
walnut, almond and hazelnut biscuits	13
white chocolate chip brownies	14
biscotti	14
pecan tart	15
white chocolate cake	15
mediterranean fruit ring	16
chocolate chip walnut loaf	16
crushed blackberry syllabub	17
no bake lemon cheesecake	17
carrot cake	18
royal icing	18

recipes

strawberries and cream sponge

serves 8-10

<i>150g (5oz) plain flour</i>	<i>300ml (½ pint) double cream</i>
<i>25g (1oz) corn flour</i>	<i>15ml (1tbsp) caster sugar</i>
<i>6 eggs</i>	<i>grated rind and juice of 1 orange</i>
<i>75g (3oz) caster sugar</i>	<i>225g (8oz) strawberries</i>
<i>75g (3oz) butter, melted</i>	<i>icing sugar, for dusting</i>

- 1 Preheat the oven to 180°C/350°F/Gas 4. Grease and base line a 23cm (9 inch) round spring-form deep cake tin. Sift the flour and cornflour together.
- 2 Fit the whisk, place the eggs and sugar in the bowl and whisk at speed 6 until very thick, pale and mixture leaves a trail.
- 3 Using a metal spoon gently fold in half the flour mixture. Pour half the butter around the edge of the bowl and fold in. Gradually fold in the remaining flour mixture and butter.
- 4 Pour into prepared tin and bake for 45-50 minutes, until well risen and golden. Turn out onto wire rack and leave to cool.
- 5 Using the whisk on speed 6, whip the cream, sugar and orange juice together until it forms soft peaks. Fold in the orange rind. Reserve 5 strawberries for decoration and slice the remainder.
- 6 Split the deep cake in half and fill with the whipped cream and sliced strawberries. Decorate the top with the reserved strawberries, dust with icing sugar and serve.

rich chocolate cake

serves 8-10

<i>200g (7oz) good quality plain chocolate, broken into pieces</i>	<i>75g (3oz) self-raising flour, sifted</i>
<i>175g (6oz) butter, softened</i>	<i>15ml (1tbsp) cocoa powder, sifted</i>
<i>175g (6oz) caster sugar</i>	<i>For the Chocolate Ganache:</i>
<i>4 eggs, separated</i>	<i>400ml (14fl oz) double cream</i>
<i>100g (4 oz) ground almonds</i>	<i>225g (8oz) good quality plain chocolate, broken into pieces</i>

- 1 Preheat the oven to 180°C/350°F/Gas Mark 4. Grease and base line a 20 cm (8inch) round spring-form cake tin. Place the chocolate in a bowl and set over a pan of simmering water, until melted.
- 2 Using the beater on speed 4, beat the butter and sugar together in the bowl, until pale and fluffy. Gradually beat in egg yolks.
- 3 On speed 1, mix in ground almonds and melted chocolate. Mix in the flour and cocoa powder and transfer to a large bowl.
- 4 Using the whisk on speed 6, whisk the egg whites until stiff. Using a metal spoon, fold the egg whites into the cake mixture, until well combined.
- 5 Transfer to the prepared tin and bake for 45-50 minutes or until just firm to the touch. Cool in tin for 5 minutes and then transfer to a wire rack to cool.
- 6 Meanwhile for the ganache: place the cream in a saucepan and bring to the boil. Remove from the heat, add the chocolate pieces and stir until melted. Leave to cool and chill until thickened.
- 7 Split the cake and use the ganache to sandwich back together and spread remaining over the top, giving a swirled effect.

recipes

gingerbread

serves 8

<i>300g (10oz) plain flour</i>	<i>100g (4oz) light brown muscovado sugar</i>
<i>10ml (2tsp) ground ginger</i>	<i>150ml (¼ pint) milk</i>
<i>5ml (1tsp) mixed spice</i>	<i>2 eggs</i>
<i>2.5ml (½ tsp) baking powder</i>	<i>100g (4oz) drained stem ginger in syrup, thinly sliced</i>
<i>7.5ml (1½ tsp) bicarbonate of soda</i>	<i>30ml (2tbsp) stem ginger syrup or warmed golden syrup, to serve</i>
<i>100g (4oz) butter</i>	
<i>50g (2oz) treacle</i>	
<i>150 g (5oz) golden syrup</i>	

- 1 Preheat the oven to 170°C/325°F/Gas Mark 3. Grease and line a 18cm (7 inch) square cake tin. Sift the flour, ground ginger, mixed spice, baking powder and bicarbonate of soda into the bowl.
- 2 Place the butter, treacle, golden syrup and sugar in a small saucepan and heat gently, stirring occasionally, until butter is melted.
- 3 Using the beater on speed 1, mix the melted mixture, milk, eggs and 75g (3oz) of stem ginger into the dry ingredients until well combined. Pour into the prepared tin and sprinkle over the remaining stem ginger.
- 4 Bake for 1-1½ hours, or until risen and just firm. Leave to cool in the tin for 10 minutes and turn out onto a wire rack and allow to cool completely. Cut into 8 pieces. Serve drizzled with a little of the stem ginger syrup or warmed golden syrup.

raspberry streuselkucken

serves 6-8

<i>250g (9oz) self-raising flour</i>	<i>75g (3oz) ground almonds</i>
<i>5ml (1tsp) ground cinnamon</i>	<i>1 egg</i>
<i>175g (6oz) butter, softened</i>	<i>350g (12oz) raspberries</i>
<i>100g (4oz) caster sugar</i>	<i>5ml (1tsp) cornflour</i>

- 1 Preheat the oven to 200°C/400°F/Gas Mark 6. Grease a 23 cm (9inch) round cake tin. Place the flour, cinnamon and butter in the bowl, using the beater on speed 1 mix together until the mixture starts to stick together.
- 2 Add the caster sugar and ground almonds and mix to a coarse, crumbly texture. Do not over mix.
- 3 Weigh 175g (6oz) of the mixture and set aside. Add the egg to the remainder and using the beater mix to a dough.
- 4 Transfer to the prepared tin and using a metal spoon and fingers press over the base and about 2.5cm (1 inch) up the sides of the tin.
- 5 Toss together the raspberries and cornflour and place in the tin.
- 6 Sprinkle over the reserved crumble mixture and bake for 25-30 minutes, or until golden. Leave to cool for the 30 minutes and then remove from tin and place on a wire rack to cool.

recipes

lemon curd tartlets

serves 6

*1 quantity of nut shortcrust
pastry*

For filling:

75g (3oz) ricotta cheese

75g (3oz) caster sugar

juice of 2 lemons

2 eggs

125ml (4fl oz) single cream

raspberries or blueberries, to decorate

icing sugar, to dust

- 1 Roll pastry out on a lightly floured work surface and using a 11cm (4½ inch) round plain or fluted cutter, cut out 6 rounds and use to line 6 jumbo muffin tins. Prick the cases with a fork, line with non-stick baking parchment and fill with baking beans. Cover and chill for 20 minutes.
- 2 Pre-heat the oven to 190°C/375°F/Gas 5 and bake the pastry cases for 10 minutes. Remove the baking beans and paper and bake for a further 5 minutes.
- 3 Meanwhile to make the filling: using the whisk on speed 2, whip the ricotta cheese and sugar together in the bowl, until well combined. Then with the whisk still running gradually whip in the lemon juice, until smooth. Whisk in eggs and cream.
- 4 Reduce the oven to 180°C/350°F/Gas 4. Divide the lemon filling between the tartlet cases and bake for 20 minutes or until filling is set.
- 5 Transfer the tartlets to a cooling rack and leave until cold. Top with a few raspberries or blueberries and sprinkle with icing sugar.

shortcrust pastry and variations

makes sufficient enough pastry for 20-23cm (8-9inch) flan case

*175g (6oz) plain flour
pinch of salt*

*75g (3oz) butter or margarine cut to small pieces
3 tbsp cold water*

- 1 Place the flour, salt and butter in the bowl. Using the beater at speed 1, mix until it resembles fine breadcrumbs.
- 2 Add the water to the mixture, whilst the beater is still turning until the mixture forms a dough.
- 3 Turn out onto a lightly floured work surface and knead lightly. Do not over-handle the dough. Wrap in clear film and leave to chill and rest in the fridge for 30 minutes before rolling out.

Variations:

Nut Pastry: add 25g (1oz) very finely chopped or ground almonds, hazelnuts or walnuts to the breadcrumb mixture at the end of step 1.

Rich Flan Pastry: use an egg yolk or whole egg, lightly beat into the mixture in step 2, adding the egg first, then add sufficient water to form a dough.

Sweet Rich Flan Pastry: add 10-15ml (2-3 tsp) caster sugar at the end of step 1.

recipes

citrus meringue pie

serves 6-8

1 quantity of rich flan pastry

see page 11

1 lemon

2 oranges

2 limes

65g (2½ oz) cornflour

50g (2oz) caster sugar

3 egg yolks

For the meringue:

3 egg whites

150g (5oz) caster sugar

grated lime zest, to decorate

- 1 Roll out pastry on a lightly floured work surface and use to line a 23cm (9inch) fluted flan tin. Prick the base with a fork and chill for 30 minutes. Preheat oven to 190°C/375°F/Gas 5.
- 2 Line the pastry case with greaseproof paper and baking beans and bake blind for 15 minutes. Remove the paper and beans and bake for a further 5 minutes. Meanwhile grate the rind from the lemon and 1 orange and set aside. Halve the citrus fruits and squeeze the juice and make up to 450ml (¾ pint) with cold water.
- 3 Mix the cornflour to a smooth paste with 120ml (4fl oz) cold water.
- 4 Place the citrus juice mixture in a saucepan with the lemon and orange rind and sugar and bring to the boil. Remove the pan from the heat and allow to cool slightly. Beat in the cornflour mixture, return to the heat and heat gently, stirring constantly, until thickened. Beat in the egg yolks and pour into the pastry case.
- 5 To make the meringue, place the egg whites in the bowl and using the whisk on speed 6, whisk the egg whites until stiff but not dry. Gradually whisk in the caster sugar until very stiff.
- 6 Spoon the meringue over the citrus filling. Bake for 5-10 minutes or until golden. Serve warm or cold.

pavlova

serves 6-8

4 egg whites

225g (8oz) caster sugar

5ml (1tsp) cornflour

5ml (1tsp) white wine vinegar

2.5ml (½ tsp) vanilla essence

300ml (½ pint) double cream

450g (1lb) fresh soft fruits

eg strawberries, raspberries or

peaches, plums and pineapple sliced

- 1 Preheat the oven to 130°C/250°F/Gas ½. Line a baking sheet with baking parchment paper and draw a 23cm (9inch) round circle.
- 2 Place the egg whites in the bowl. Using the whisk at speed 6, whisk the egg whites, until stiff. Gradually add the sugar, a few spoonfuls at a time, whisking well after each addition until stiff and glossy.
- 3 Mix the corn flour, vinegar and vanilla essence together and fold in using a metal spoon. Spoon the meringue onto the prepared baking sheet to fill the circle, making a large shallow well in the centre.
- 4 Bake for 1½ hours or until dry but still a little soft in the centre. Switch off the oven and leave the meringue to cool in the oven for a least 3 hours. Transfer to wire rack to cool.
- 5 Using the Whisk on speed 6, whip the cream until it forms soft peaks. Fill the centre of the meringue with whipped cream and pile the fruits on top.

recipes

white chocolate mousse

serves 4

*175g (6oz) white chocolate,
broken into pieces
90ml (3fl oz) milk
2 egg whites*

*1.25ml (¼ tsp) lemon juice
225ml (8fl oz) double cream
grated plain chocolate, to decorate*

- 1 Place the chocolate in a large bowl set over a pan of simmering water, until melted. Stir in the milk and set aside.
- 2 Using the whisk on speed 6, whip the egg whites and lemon juice until stiff, then using a metal spoon fold into the chocolate mixture, until well combined.
- 3 Using the whisk on speed 6, whip the double cream, until it forms soft peaks. Gently fold into the chocolate mixture.
- 4 Divide the mousse between four glasses and chill for at least 2 hours. Sprinkle with grated chocolate and serve.

walnut, almond & hazelnut biscuits

makes 20 biscuits

*100g (4oz) hazelnuts
5 egg yolks
100g (4oz) caster sugar
2.5ml (½tsp) vanilla essence*

*50g (2oz) chopped walnuts
finely grated rind of 1 orange
50g (2oz) flaked almonds*

- 1 Preheat the oven to 150°C/300°F/Gas 2. Chop hazelnuts. Using the beater on speed 3-4, cream together the egg yolks, sugar and vanilla essence in the bowl. Add the walnuts, hazelnuts and orange rind.
- 2 Line a baking sheet with baking parchment paper and spoon small amounts of the mixture onto the prepared sheet, pressing down slightly. There should be enough mixture for 20 biscuits.
- 3 Sprinkle the flaked almonds over the biscuits, pressing in slightly and bake for 18-20 minutes, until golden brown. Leave to cool on the baking sheet then store in an airtight container.

recipes

white chocolate chip brownies

makes 16

<i>100g (3½oz) hazelnuts or walnuts</i>	<i>2 eggs</i>
<i>75g (3oz) white chocolate</i>	<i>75g (3oz) caster sugar</i>
<i>175g (6oz) white chocolate chips</i>	<i>5ml (1tsp) vanilla essence</i>
<i>50g (2oz) butter</i>	<i>75g (3oz) self-raising flour</i>

- 1 Preheat the oven to 180°C/350°F/Gas 4. Lightly grease and line an 18cm (7 inch) square tin. Roughly chop the nuts and set aside for later.
- 2 Place the white chocolate broken into pieces into a small saucepan with the butter and heat very gently until melted, stirring continuously. Leave to cool for 5 minutes.
- 3 Place the eggs, sugar, flour, vanilla and melted mixture into the bowl and mix together with the beater on speed 4, until smooth. Add the chopped nuts and the white chocolate chips. Mix to combine.
- 4 Transfer to the prepared tin and bake for 30-35 minutes. Leave to cool in the tin then cut into small squares to serve.

biscotti

makes 24

<i>50g (2oz) flaked almonds</i>	<i>225g (8oz) plain flour</i>
<i>50g (2oz) butter, softened</i>	<i>10ml (2tsp) baking powder</i>
<i>100g (4oz) caster sugar</i>	<i>5ml (1tsp) ground coriander</i>
<i>1 egg</i>	<i>40g (1½ oz) polenta</i>
<i>15ml (1tbsp) orange liqueur</i>	<i>50g (2oz) pistachio nuts,</i>
<i>finely grated rind 1 small orange</i>	<i>roughly chopped</i>

- 1 Preheat the oven to 170°C /325°F/Gas 3. Roast almonds for 5-10 minutes, cool and very coarsely chop. Lightly grease a baking sheet.
- 2 Using the beater on speed 6, beat the butter and sugar in the bowl, until pale and smooth. Beat in the egg, liqueur and orange rind. Add the flour baking powder, ground coriander and polenta to the bowl and mix at speed 1 to make a soft dough. Add the nuts and beat at speed 1, until well combined.
- 3 Turn out onto a lightly floured work surface and knead slightly. Halve the mixture and shape each into a 5cm wide, 2cm (¾ inch) deep rectangular shape.
- 4 Place on the prepared baking sheet and chill for 20 minutes. Bake for about 30 minutes until just firm. Transfer to a wire rack to cool for about 10 minutes then cut diagonally into 1cm (½ inch) wide slices.
- 5 Place the Biscotti cut side down on the baking sheet and bake for a further 10 minutes, until crisp. Cool on a wire rack, store in airtight container.

recipes

pecan tart

serves 6

*1 quantity of rich flan pastry
see page 11
175g (6oz) pecan nuts
175g (6oz) light soft brown sugar
15ml (1tbsp) golden syrup*

*40g(1½oz) butter, melted
5ml (1tsp) vanilla essence
180ml (6floz) evaporated milk
2 eggs, beaten*

- 1 Roll out the pastry and use to line a 23cm (9inch) fluted flan tin. Prick the base with a fork and cover and chill for 20 minutes.
- 2 Preheat the oven to 190°C/375°F/Gas Mark 5. Line the pastry case with greaseproof paper and baking beans and bake for 10 minutes. Remove the beans and paper and bake for a further 5 minutes. Remove from the heat. Reduce the oven temperature to 170°C/325°F/Gas Mark 3.
- 3 Chop 100g (4oz) of the pecan nuts and set aside the remaining. Using the whisk on speed 5, whisk together the remaining ingredients, until well combined.
- 4 Pour onto the pastry case and arrange the reserved pecan halves in concentric circles on top.
- 5 Bake for 35-40 minutes, until golden and firm to the touch. Serve accompanied by ice cream or whipped cream.

white chocolate cake

serves 8

For the cake:

*150g (5oz) butter, softened
300g (10oz) caster sugar
4 eggs
1 tsp vanilla extract
350g (12oz) plain flour
12.5ml (2½tsp) baking powder*

2.5ml (½tsp) salt

*280ml (8floz) milk
250g (9oz) white chocolate, melted*

For the truffle topping:

*250g (9oz) white chocolate, broken into pieces
280ml (8floz) double cream
Dark chocolate shavings, to decorate*

- 1 For the cake: preheat the oven to 180°C/350°F/Gas 4. Grease and line the bases of two 20cm (8 inch) round cake tins.
- 2 Using the beater on speed 4, beat the butter to soften. Add the sugar and beat until pale and fluffy. Gradually beat in the eggs and vanilla essence, adding a little flour, to prevent curdling.
- 3 Sieve the remaining dry ingredients into the bowl beating in at speed 1. Blend the chocolate and milk together and then beat into the cake mixture.
- 4 Divide the batter between the two tins and bake for 30 minutes. Cool in the tins for 10 minutes and then turn out onto a wire rack to cool.
- 5 To make the topping, place the chocolate in a bowl set over a pan of simmering water until melted. Remove from the heat.
- 6 Using the whisk at speed 6, whip the cream until soft peaks form. Fold the chocolate into the cream and use to sandwich the cakes together and spread the remaining mixture over the top of the cake. Decorate with the dark chocolate shavings. Chill before serving.

recipes

mediterranean fruit ring

serves 6

makes 1 loaf

<i>450g (1lb) strong plain white flour</i>	<i>75g (3oz) sultanas</i>
<i>5ml (1tsp) ground cinnamon</i>	<i>50g (2oz) caster sugar</i>
<i>2.5ml (½tsp) ground ginger</i>	<i>grated rind of ½ lemon</i>
<i>2.5ml (½tsp) salt</i>	<i>15ml (1tbsp) olive oil</i>
<i>7g sachet (1½ tsp) fast action dried yeast</i>	<i>300ml (½ pint) lukewarm milk</i>
<i>50g (2oz) chopped almonds or walnuts</i>	<i>beaten egg, to glaze</i>

- 1 Sift the flour cinnamon, ginger and salt into the bowl. Add the yeast, nuts, sultanas, sugar, lemon, olive oil and milk. Fit the dough hook and mix to a soft dough on speed 1.
- 2 Then increase speed to 2-3 and knead for a further 7 minutes until smooth and elastic. Remove the dough from the bowl and form into a ball. Return to the bowl, cover, leave to rise in warm place for 1-1½ hours or until doubled in size.
- 3 Transfer the dough to a floured surface and divide into 3 equal pieces. Roll each into a rope shape 62cm (25 inches) long. Lay them side by side.
- 4 Starting at one end, plait the pieces together. Bring the ends together to form a circle and pinch to seal.
- 5 Place on a lightly oiled baking sheet, cover with oiled clear film and leave in a warm place to rise for 30-45 minutes until doubled in size. Preheat oven to 200°C/400°F/Gas 6.
- 6 Brush with beaten egg to glaze and bake for 20-25 minutes or until risen and golden. Transfer to wire rack to cool. Serve sliced.

chocolate chip walnut loaf

serves 6

makes 1 loaf

<i>75g (3oz) caster sugar</i>	<i>5ml (1tsp) vanilla extract</i>
<i>85g (3½oz) flour</i>	<i>30ml (2tbsp) currants or raisins</i>
<i>5ml (1tsp) baking powder</i>	<i>25g (1oz) walnuts, chopped</i>
<i>60ml (4tbsp) corn flour</i>	<i>grated rind of ½ a lemon</i>
<i>130g (4½oz) butter, softened</i>	<i>45ml (3tbsp) plain chocolate chips</i>
<i>2 eggs</i>	<i>icing sugar, for dusting</i>

- 1 Preheat the oven to 180°C/350°F/Gas 4. Grease and line a 450g (1lb) loaf tin. Sprinkle 10ml (2tsp) of the caster sugar into the pan evenly to coat the base and sides.
- 2 Sift the flour, baking powder and corn flour into a bowl. Using the beater on speed 5-6, cream the butter to soften. Add the remaining sugar and continue beating until light and fluffy. Gradually beat in the eggs, adding a little of the flour mixture to prevent curdling.
- 3 Gently fold in the remaining flour mixture, do not over mix. Fold in the vanilla, currants or raisins, walnuts, lemon rind and chocolate chips until combined.
- 4 Spoon into the tin and bake for 45-50 minutes. Allow to cool in the tin for 15 minutes, before transferring to a wire rack to cool completely. Dust over an even layer of icing sugar before serving.

recipes

crushed blackberry syllabub

serves 4-6

300g/10oz ripe blackberries *300ml (¼pt) double cream*
75g/3oz caster sugar *30ml (2tbsp) brandy*
finely grated rind and juice of ½ lemon

- 1 Using the beater on speed 3, crush the blackberries with the sugar and lemon zest until you have knobbly, runny mush. Beat in the lemon juice and the cream.
- 2 Change the beater to a whisk and on speed 5, whisk the mixture, adding the brandy when its beginning to thicken. Carry on whisking until thick and light, but still floppy.
- 3 Spoon into individual glasses. Either serve immediately or chill until ready to eat.

no bake lemon cheesecake

serves 6-8

175g (6oz) digestive biscuits *150g (5oz) caster sugar*
50g (2oz) butter *grated rind and juice of 3 large lemons*
25g (1oz) Demerara sugar *450ml (¾pt) double cream*
350g (12oz) full fat soft cheese *Fresh seasonal fruit, to decorate*

- 1 Finely crush digestive biscuits in a bag with a rolling pin. Melt the butter in a pan and add the Demerara sugar and biscuit crumbs and stir well to mix.
- 2 Turn biscuit mixture into 20cm (8inch) round spring-form cake tin and press firmly with a spoon.
- 3 Using the whisk on speed 2, beat the soft cheese and sugar together, until smooth. Gradually add lemon zest and juice and beat until well combined. Spoon into a separate bowl.
- 4 Using the whisk on speed 5, whip the double cream until it forms soft peaks. Fold the whipped cream into the cheese mixture.
- 5 Slowly pour cheese mixture into the cake tin so that it evenly covers biscuit bottom. Level surface, cover and leave in refrigerator overnight until well chilled and set.
- 6 Loosen tin side from cheesecake and slide onto plate. Decorate with seasonal fresh fruit.

recipes

carrot cake

makes 24

<i>10ml (2tsp) baking powder</i>	<i>3 eggs</i>
<i>10ml (2tsp) bicarbonate of soda</i>	<i>250g (9oz) crushed pineapple with juice</i>
<i>2.5ml (½tsp) salt</i>	<i>175g (6oz) chopped toasted pecans or walnuts</i>
<i>10ml (2tsp) ground cinnamon</i>	<i>50g (2oz) desiccated coconut</i>
<i>5ml (1tsp) ground nutmeg</i>	<i>250g (9oz) grated carrots</i>
<i>2.5ml (½tsp) ground cloves</i>	<i>175g (6oz) raisins</i>
<i>60ml (4tbsp) vegetable oil</i>	<i>500g (1lb2oz) plain flour</i>
<i>225g (8oz) caster sugar</i>	
<i>65g (2½oz) light soft brown sugar</i>	
<i>10ml (2tsp) vanilla essence</i>	

- 1 Preheat oven to 180°C / 350°F / Gas 4. Grease a 33cm x 25cm (13 x 9 inch) cake tin. Sift the flour, baking powder, bicarbonate of soda, salt, cinnamon, nutmeg and cloves into a bowl and set aside.
- 2 Using the beater on speed 2-3, beat together the oil, sugar, brown sugar, vanilla, and eggs, until smooth. Reduce speed to 1 and add pineapple, walnuts, coconut, carrots and raisins until well mixed.
- 3 Gradually beat in the flour mixture on speed 1, until well combined. Pour mixture into the tin and bake for 40-50 minutes. Turn out onto a wire rack to cool. Cut into 24 pieces. Serve on its own or with butter.

royal icing

six egg whites
1500gms (50oz) of icing sugar

- 1 Add the six egg whites to the bowl
- 2 Fit the beater, on speed 1 gradually add the icing sugar over a period of approx. 2 to 3 minutes increasing the speed to 6 as the ingredients combine.
- 3 As soon as the ingredients have combined continue to run for a further 45seconds.
- 4 Makes a quantity suitable for 2 x 20cm (8inch) round cakes

۱۱.۱۱.۱

چراغی که در این مرحله به شما نشان داده می‌شود، باید در حالت روشن قرار گیرد. در این مرحله، چراغ را روشن کنید و در صورت لزوم، آن را خاموش کنید. در این مرحله، چراغ را روشن کنید و در صورت لزوم، آن را خاموش کنید.

- در این مرحله، چراغ را روشن کنید و در صورت لزوم، آن را خاموش کنید.
- در این مرحله، چراغ را روشن کنید و در صورت لزوم، آن را خاموش کنید.
- در این مرحله، چراغ را روشن کنید و در صورت لزوم، آن را خاموش کنید.
- در این مرحله، چراغ را روشن کنید و در صورت لزوم، آن را خاموش کنید.

چراغ
روشن

خاموش

- در این مرحله، چراغ را روشن کنید و در صورت لزوم، آن را خاموش کنید.
- در این مرحله، چراغ را روشن کنید و در صورت لزوم، آن را خاموش کنید.
- در این مرحله، چراغ را روشن کنید و در صورت لزوم، آن را خاموش کنید.

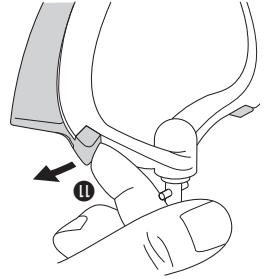

۱۱.۱۱.۲

- در این مرحله، چراغ را روشن کنید و در صورت لزوم، آن را خاموش کنید.
- در این مرحله، چراغ را روشن کنید و در صورت لزوم، آن را خاموش کنید.
- در این مرحله، چراغ را روشن کنید و در صورت لزوم، آن را خاموش کنید.
- در این مرحله، چراغ را روشن کنید و در صورت لزوم، آن را خاموش کنید.
- در این مرحله، چراغ را روشن کنید و در صورت لزوم، آن را خاموش کنید.
- در این مرحله، چراغ را روشن کنید و در صورت لزوم، آن را خاموش کنید.
- در این مرحله، چراغ را روشن کنید و در صورت لزوم، آن را خاموش کنید.
- در این مرحله، چراغ را روشن کنید و در صورت لزوم، آن را خاموش کنید.
- در این مرحله، چراغ را روشن کنید و در صورت لزوم، آن را خاموش کنید.
- در این مرحله، چراغ را روشن کنید و در صورت لزوم، آن را خاموش کنید.

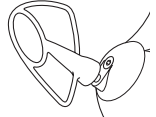
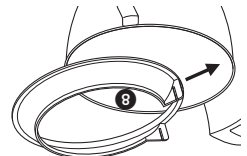
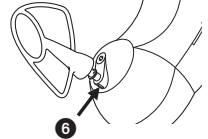
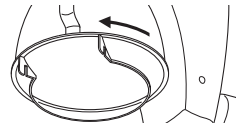
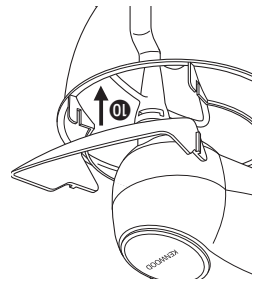

۱۱.۱۱.۳

- ١) كاس
- ٢) سلك
- ٣) سلك
- ٤) سلك
- ٥) سلك
- ٦) سلك
- ٧) سلك
- ٨) سلك
- ٩) سلك
- ١٠) سلك
- ١١) سلك
- ١٢) سلك

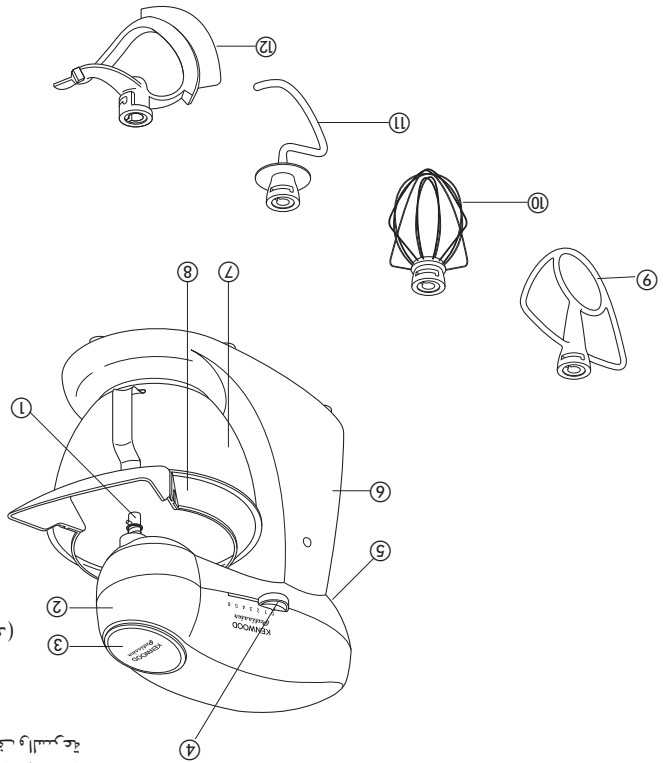

١٢) كاس



HEAD OFFICE: Kenwood Limited, 1-3 Kenwood Business Park, New Lane, Havant, Hampshire PO9 2NH

kenwoodworld.com

KENWOOD

CREATE MORE